

Tucson Hybrid

Emergency Response Guide



HYUNDAI HELP LINE
0800 HYUNDAI (498 632)

⚠ WARNING

- If severe damage causes high-voltage components to become exposed, emergency responders should take appropriate precautions and wear appropriate insulated personal protective equipment.
- Do not attempt to remove the safety plug while standing in the water.
- Never cut or disconnect the high voltage orange cabling and connectors without first disabling the system by removing the safety plug.
- Exposed cables or wires may be visible inside or outside the vehicle. Never touch the wires, cables, connectors, or any electric components before disabling the system, to prevent injury or death due to electrical shock.

Failure to follow any of these instructions may result in serious injury or death by electrocution.

- Do not cut through any component of the Airbag (SRS) system (Supplementary Restraint System)
- SRS components may remain powered and active for up to 3 minutes after the 12V electrical system is shut off or disabled.

Disconnect the battery negative cable and wait for at least 3 minutes before beginning work.

Failure to follow any of these instructions may result in serious injury or death from accidental deployment of the airbag system.

This manual includes information titled as DANGER, WARNING, CAUTION & NOTICE.

These titles indicate the following:

DANGER

DANGER indicates a hazardous situation which, if not avoided, will result in death or serious injury.

WARNING

WARNING indicates a hazardous situation which, if not avoided, could result in death or serious injury.

CAUTION

CAUTION indicates a hazardous situation which, if not avoided, could result in minor or moderate injury.

NOTICE

NOTICE indicates a situation which, if not avoided, could result in vehicle damage.

WARNING

- If severe damage causes high-voltage components to become exposed, emergency responders should take appropriate precautions and wear appropriate insulated personal protective equipment.
- Do not attempt to remove the safety plug while standing in the water.
- Never cut or disconnect the high voltage orange cabling and connectors without first disabling the system by removing the safety plug.
- Exposed cables or wires may be visible inside or outside the vehicle. Never touch the wires, cables, connectors, or any electric components before disabling the system, to prevent injury or death due to electrical shock.

Failure to follow any of these instructions may result in serious injury or death by electrocution.

- Do not cut through any component of the Airbag (SRS) system (Supplementary Restraint System)
- SRS components may remain powered and active for up to 3 minutes after the 12V electrical system is shut off or disabled. Disconnect the battery negative cable and wait for at least 3 minutes before beginning work.

Failure to follow any of these instructions may result in serious injury or death from accidental deployment of the airbag system.

This manual includes information titled as DANGER, WARNING, CAUTION & NOTICE.

These titles indicate the following:

DANGER

DANGER indicates a hazardous situation which, if not avoided, will result in death or serious injury.

WARNING

WARNING indicates a hazardous situation which, if not avoided, could result in death or serious injury.

CAUTION

CAUTION indicates a hazardous situation which, if not avoided, could result in minor or moderate injury.

NOTICE

NOTICE indicates a situation which, if not avoided, could result in vehicle damage.

WARNING

- If severe damage causes high-voltage components to become exposed, emergency responders should take appropriate precautions and wear appropriate insulated personal protective equipment.
- Do not attempt to remove the safety plug while standing in the water.
- Never cut or disconnect the high voltage orange cabling and connectors without first disabling the system by removing the safety plug.
- Exposed cables or wires may be visible inside or outside the vehicle. Never touch the wires, cables, connectors, or any electric components before disabling the system, to prevent injury or death due to electrical shock.

Failure to follow any of these instructions may result in serious injury or death by electrocution.

- Do not cut through any component of the Airbag (SRS) system (Supplementary Restraint System)
- SRS components may remain powered and active for up to 3 minutes after the 12V electrical system is shut off or disabled. Disconnect the battery negative cable and wait for at least 3 minutes before beginning work.

Failure to follow any of these instructions may result in serious injury or death from accidental deployment of the airbag system.

Contents

Important Safety Information	1 / 2
Introduction	3
TUCSON Hybrid Identification	4
- General Vehicle Description	4
- Identifying a Hyundai hybrid vehicle	5
TUCSON Hybrid Main Systems	9
- Key Specifications	9
- Vehicle Components Location	10
- Vehicle Components	13
- Airbag system (SRS : Supplemental Restraint System)	15
Emergency Procedures	17
- Initial response: Identify, Immobilise and Disable	17
- Extraction Operations	24
- Submersion	27
- Vehicle Fire	28
- High-Voltage Battery Damage and Fluid Leaks	29
Roadside Assistance	
- Towing	30
- Jump Starting	31

Document Purpose

The purpose of this document is to familiarise emergency responders and the towing/roadside assistance industry with the proper methods to handle the Hyundai TUCSON Hybrid in an emergency situation. This guide offers a basic overview of key vehicle systems and provides instructions for dealing with the different types of situations encountered by emergency responders. The emergency response procedures for this vehicle are somewhat similar to a conventional vehicle with additional information provided on dealing with the high-voltage electrical system.

Vehicle Description

As with other Hybrids, the Hyundai TUCSON Hybrid uses a conventional petrol powered internal combustion engine paired with a high-voltage electric motor to propel the vehicle. The high-voltage electrical system is completely self-contained and does not need to be recharged by an external power source such as a charging station through charging port. The high-voltage battery is recharged while the vehicle is being driven. This is accomplished through the use of a generator that produces electricity during driving and braking.



General Vehicle Description

The Hyundai TUCSON Hybrid is built on a conventional TUCSON chassis and therefore the five door hatch back looks very similar to its conventional counterpart with a few notable exceptions. The safest method is to assume that any TUCSON you respond to could be a hybrid vehicle until proven otherwise. Using the information provided in this section, responders will be able to differentiate between the two.

Identifying a Hyundai hybrid vehicle

“HYBRID” badge on the boot / tailgate of the vehicle

The Hyundai TUCSON HYBRID can be easily identified by the ‘HYBRID’ and the ‘TUCSON’ badge located on the tailgate of the vehicle.

⚠ DANGER

Electrocution Risk

Badging can become hidden after a crash due to damage to the vehicle. Always be sure to utilise additional methods if identification before determining there is no badge present.



VIN number

The Vehicle Identification Number (VIN) identifies the Electric Vehicle with a “1” (*Number one*) displayed in the 8th position, as shown in the below drawing.

The VIN is punched on the floor under the driver seat. The number “1” in the 8th character of the VIN indicates that it is a hybrid vehicle with a 1.6ℓ Turbo Petrol Engine.

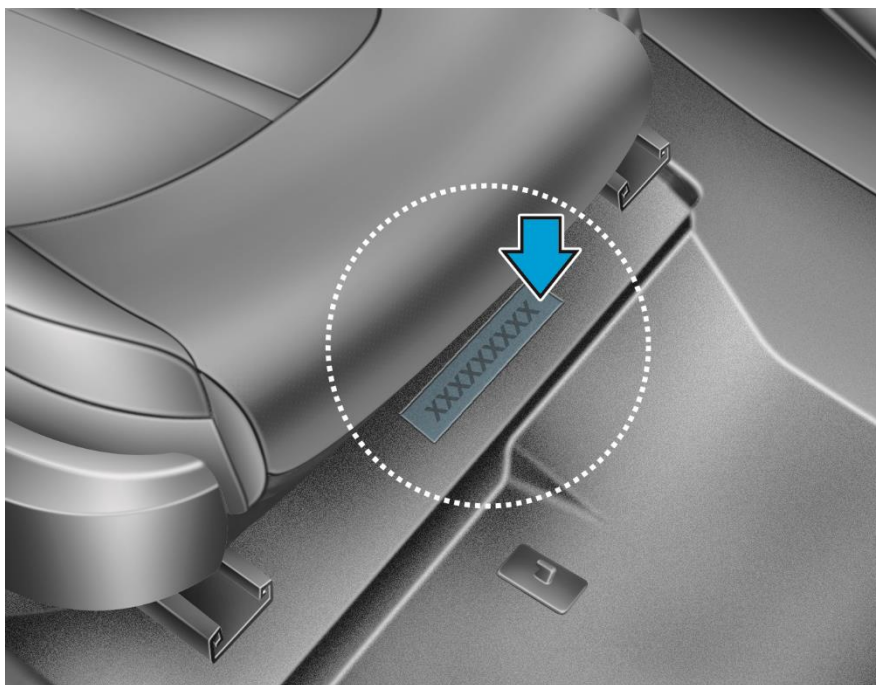
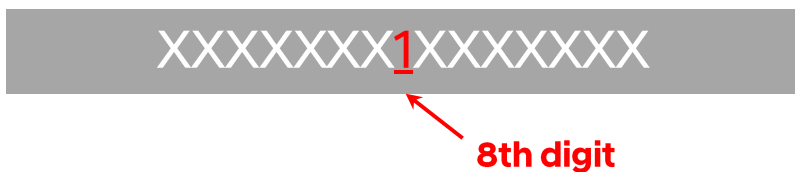

VIN stamped in frame, under driver's seat



VIN Label, front windscreen passenger side



VIN Label, front passenger “B-Pillar”

Engine Compartment

The TUCSON Hybrid has a plastic air cleaner assembly with “HYBRID” clearly shown on it.



Additionally, there are orange coloured high-voltage electrical cables in the engine compartment.

Vehicle Underside

An orange coloured cable covered by the under cover is also visible on the underside of the vehicle. This cable runs from the center of the vehicle to the engine compartment.

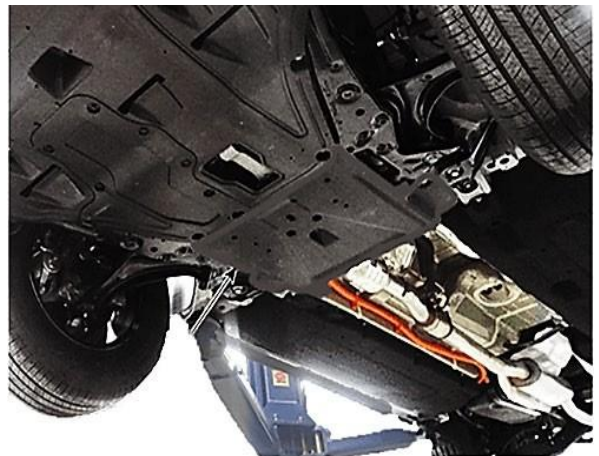

WARNING

Electrocution Risk!

- Never cut or disconnect the high voltage orange cabling and connectors without first disabling the system by removing the safety plug.
- Exposed cables or wires may be visible inside or outside the vehicle. Never touch the wires, cables, connectors, or any electric components before disabling the system, to prevent injury or death due to electrical shock.

Failure to follow these instructions can lead to death by electrical shock.

Hybrid Vehicle Cluster Instrument Panel

Hybrid Vehicle Instrument Cluster Panel displays the electric vehicle specific features that identify the TUCSON as a Hybrid vehicle.

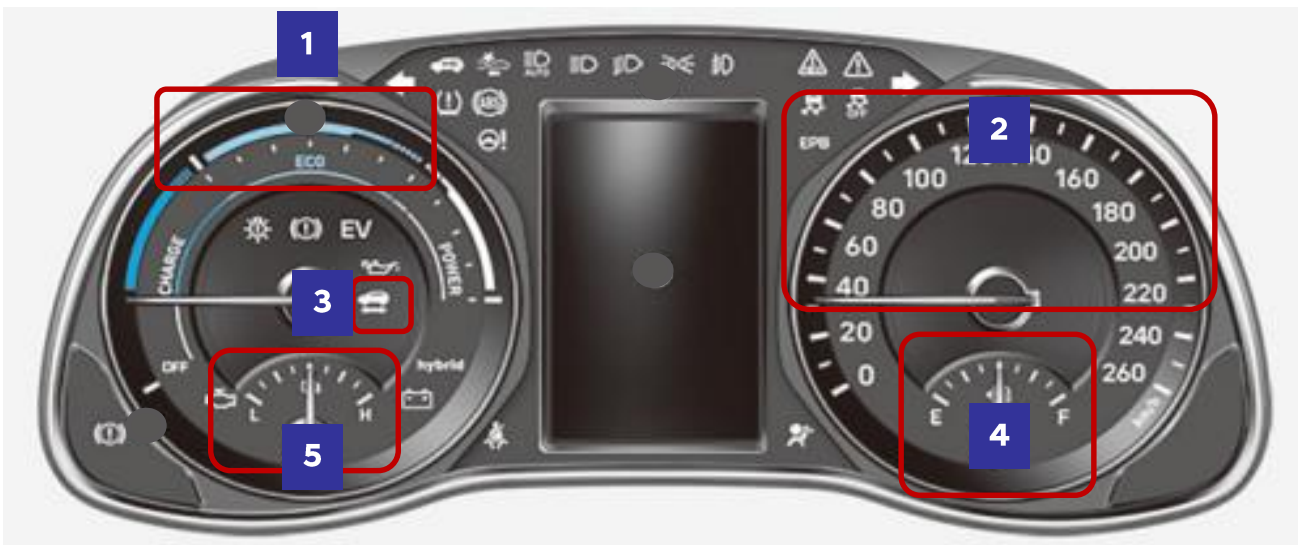
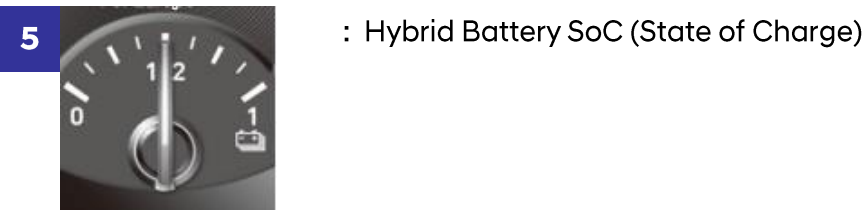
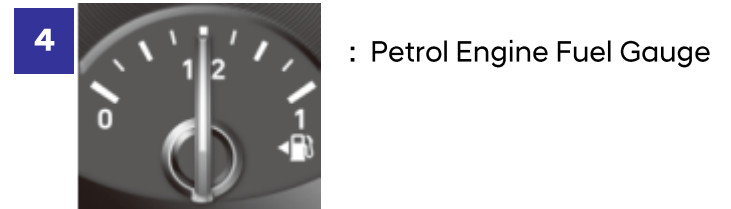
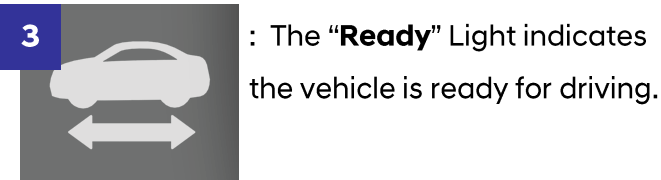

Key Specifications

Item		Hybrid
Engine	Type	KAPPA 1.6ℓ TURBO ATKINSON GDI (Gasoline Direct Injection)
		Displacement : 1,580 cc
	Max. Power (kW)	132 kW @ 5,500 rpm
	Max Torque (Nm)	265 Nm @ 1,500 ~ 4,000 rpm
Transmission	Type	6-Speed Automatic Transmission (with HTRAC)
Electric Traction Motor	Type	Permanent Magnet Synchronous Motor
	Max. Power (kW)	44.2 kW (combined – 169 kW)
	Max Torque (Nm)	264 Nm (combined – 350Nm)
High Voltage Battery	Type	Lithium-ion Polymer (Pouch Type)
	Rated Voltage (V)	240
	Capacity (kWh)	1.49
	Number for Cells	16 Cells (4 Modules)
	Weight (kg)	Approx. 15

Vehicle Components Location

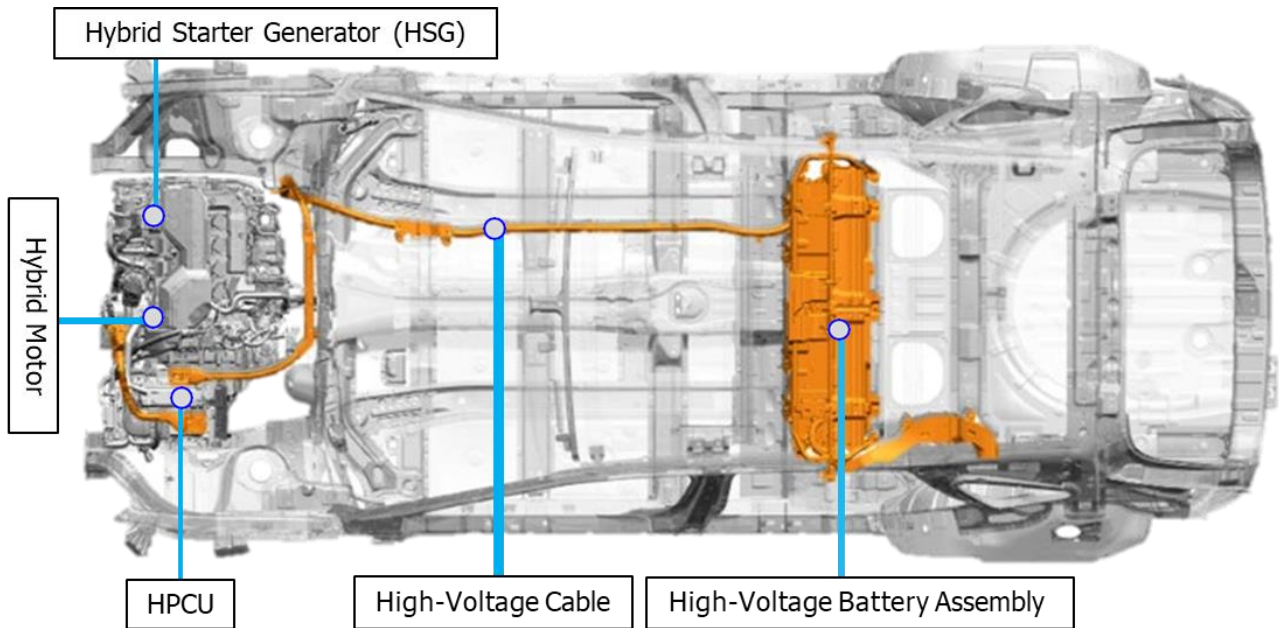

HPCU	Hybrid Power Control Unit
Hybrid Motor	When current flows through the coil. It generates a rotating magnetic field and generates motor torque.
H.V. Battery	Supplies electric energy to traction motor and stores generated electric energy.
H.V. Cable	The high-voltage cabling is orange per the SAE standard.

⚠ WARNING

Electrocution Risk!

- Never cut or disconnect the high voltage orange cabling and connectors without first disabling the system by removing the safety plug.
- Exposed cables or wires may be visible inside or outside the vehicle. Never touch the wires, cables, connectors, or any electric components before disabling the system, to prevent injury or death due to electrical shock.

Failure to follow these instructions can lead to death by electrical shock.

Vehicle Components

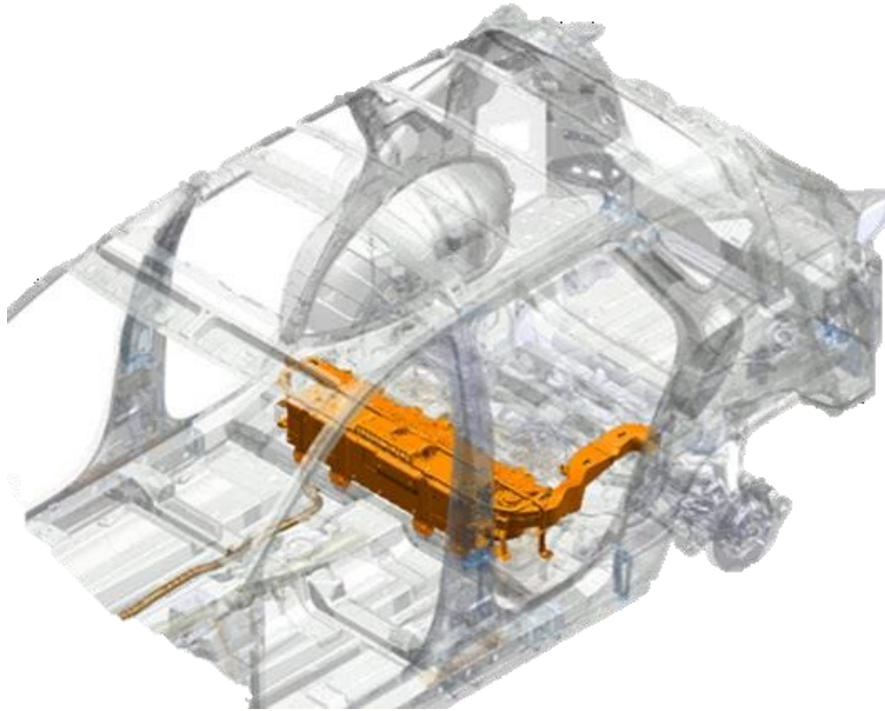

High-Voltage (HV) Battery

The High-Voltage battery is located under the rear bench seat.

BMS (Battery Management System)

The BMS is located inside the High-Voltage Battery assembly and measures several parameters to maintain the optimal performance of the High-Voltage Battery.

In addition, if a system fault occurs, the BMS turns off the PRA to protect the system.

PRA (Power Relay Assembly)

The PRA is located inside the High-Voltage Battery Pack Assembly and controls the high-voltage power circuit between the High-Voltage Battery and the Hybrid Power Control Unit.

12V Auxiliary Battery

Lithium ion polymer type integrated into the HEV high voltage battery.

WARNING

Electrocution Risk!

- Never cut or disconnect the high voltage orange cabling and connectors without first disabling the system by removing the safety plug.
- Exposed cables or wires may be visible inside or outside the vehicle. Never touch the wires, cables, connectors, or any electric components before disabling the system, to prevent injury or death due to electrical shock.

Failure to follow these instructions can lead to death by electrical shock.

Petrol Engine

Specially calibrated internal combustion engine
1.6-litre Turbo GDI direct injection petrol engine.
Santa Fe Hybrid is powered by this engine and
an electric drive motor, which uses energy
stored in the battery. Santa Fe Hybrid cannot
be plugged in to charge the high voltage
battery. Instead, the battery is charged through
regenerative braking and by the internal
combustion engine.



Electric Drive Motor

Mounted between the petrol engine &
automatic transmission. Electric Drive Motor is
used for vehicle propulsion when in EV mode &
Hybrid Mode. During deceleration or braking, it
acts as a generator and charges the high
voltage battery by converting the vehicle's
kinetic energy into electrical energy.



Transmission

The 6-speed Automatic Transmission is mated
to the Electric Drive Motor and then provide the
driveline to the front & rear wheels (all-wheel
drive) *HTRAC*.



Lithium-ion High Voltage Battery

The 1.49 kWh high-voltage battery

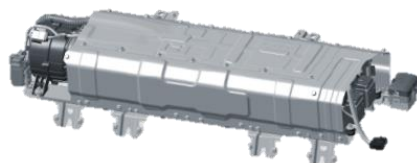

WARNING

Electrocution Risk!

- Never cut or disconnect the high voltage orange cabling and connectors without first disabling the system by removing the safety plug.
- Exposed cables or wires may be visible inside or outside the vehicle. Never touch the wires, cables, connectors, or any electric components before disabling the system, to prevent injury or death due to electrical shock.

Failure to follow these instructions can lead to death by electrical shock.

Airbag System (SRS : Supplemental Restraint System)

Airbag

Six airbags are installed in the Tucson Hybrid as shown below. Before starting any emergency procedure, make sure the vehicle ignition is turned off, disconnect the negative cable from the 12V auxiliary battery to prevent accidental deployment of airbags.

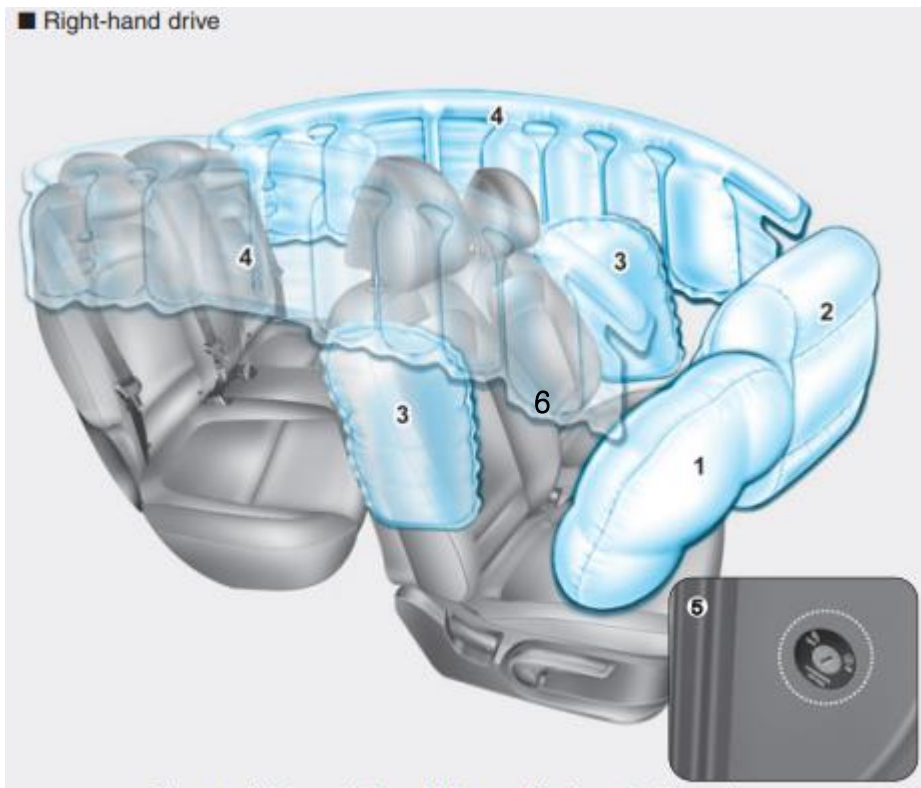

* The actual air bags and seats in the vehicle may differ from the illustration

Number	Name	Location
1	Driver's front airbag	Driver side
2	Passenger's front airbag	Passenger side
3	Side airbag (x2)	Driver / Passenger side
4	Curtain airbag (x2)	Driver / Passenger side
5	Passenger Airbag Switch	Passenger side
6	Driver's center airbag	Driver side

Seat Belt Pretensioners

The TUCSON Hybrid is equipped with seat belts with pretensioners. When the seat belt pretensioners are activated in a collision, a loud noise may be heard and fine dust, which may appear to be smoke, may be visible in the passenger compartment. These are normal operating conditions and are not hazardous. The seat belt pretensioner assembly mechanisms may become hot during activation, and may need several minutes to cool after they have been activated.

Sensors and Control Module

The airbags and pretensioners are managed by the SRS Control Module, or SRSCM, which is located below the front of the center console. In addition, there are four side impact sensors : two conventional accelerometer sensors in the B-pillars, and two pressure sensing sensors inside of the front door modules. Their locations are illustrated in the image below.

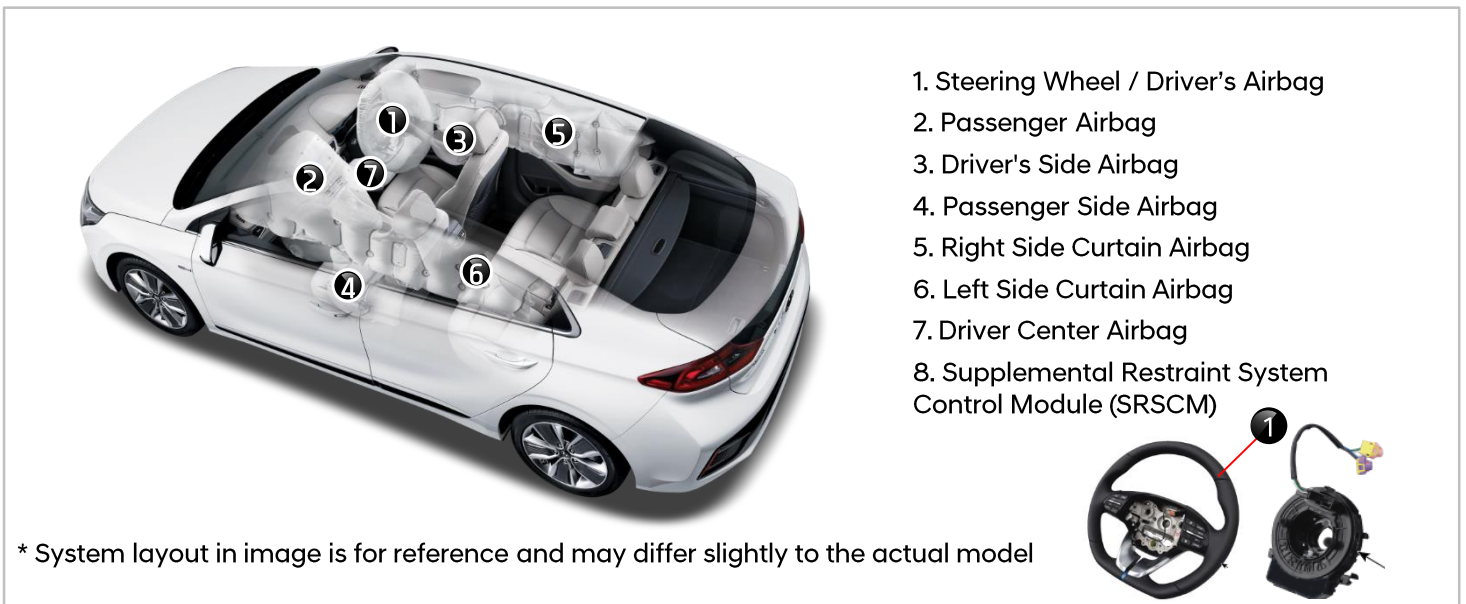

⚠ WARNING

- Do not cut through any component.
- SRS components may remain powered and active for up to 3 minutes after the 12V electrical system is shut off or disabled. Disconnect the battery negative cable and wait for at least 3 minutes before beginning work.

Failure to follow any of these instructions may result in serious injury or death from accidental deployment of the airbag system.

Initial Response:

The following procedures should be used whenever you are dealing with a TUCSON Hybrid at an emergency scene. All other operations should be consistent with your department's standard operating procedures or guides. Hybrid vehicles damaged by a crash may have compromised high voltage safety systems and present a potential high voltage electrical shock hazard. Exercise caution and wear appropriate personal protective equipment (PPE) safety gear, including high voltage safety gloves and boots. Remove all metallic jewelry, including watches and rings.

Identify

When dealing with a TUCSON at the scene of an accident, emergency responders should always assume that it is a electric model until it can be proven otherwise using the identification features outlined in this ERG. External badging will usually be the first clue but it can often be hidden by damage caused in a crash. Always be sure to inspect multiple sides of the vehicle as well as using the clues found under the hood and in the interior of the vehicle.



Immobilise

The next step is to immobilise the vehicle to prevent any accidental movement that can endanger the emergency response personnel and any crash victims. Since the TUCSON Hybrid has the ability to shut down the petrol engine when it is not needed, there will be instances where the vehicle appears to be off because of the absence of engine noise. When in its “Ready” mode, the vehicle can move almost silently using the electric motor alone. Responders should approach the vehicle from the sides and stay away from the front or rear as they are both potential paths of travel. Instructions for immobilising the vehicle are shown below.



Step on brake pedal to park the vehicle, then select the shift lever in park (P)



Engage Parking Brake



Press the “POWER” START/STOP Button



Chock the Rear Wheels

Disable

The final step in the initial response process, conducted after the vehicle is secured to prevent movement, is to disable the vehicle, its SRS components and the high voltage electrical system. To prevent current flow through the system, use one of the following procedures to disable the vehicle.

I . Disabling the system – Smart Key System and “POWER” START/STOP BUTTON

1. 1. Check the status of the READY light on the instrument panel. If the READY light is illuminated, the vehicle is on.

(Refer to page 5)

a) If the READY light is NOT illuminated, the vehicle is off, Do not push the “POWER” START/STOP button because the vehicle may restart.

b) To turn off the system, put the shift lever in the P (Park) position and press the POWER button beside a shift lever.



“POWER” START/STOP Button

Without depressing the brake pedal

Pressing POWER button	Button Position	Vehicle condition
	OFF	Off
One time	ACC	Electrical accessories are operational.
Two times	ON	The warning lights can be checked before the vehicle is started.
Three times	OFF	Off

Depressing the brake pedal while a shift lever is in the P (Park) position

Pressing POWER button	Button Position	Vehicle condition
	OFF	Off
One time	-	Ready to drive

2. Before disconnecting the 12V auxiliary battery, move the smart key at least 2 meters away from the vehicle to prevent accidental restart.



3. Separate the positive (+) 12V battery cable (A), located at the engine room, to further prevent the risk of accidental restart.

NOTICE

If necessary, lower the windows, unlock the doors and open the trunk as required, before disconnecting the 12V battery. Once the 12V battery is disconnected, power controls will not operate.

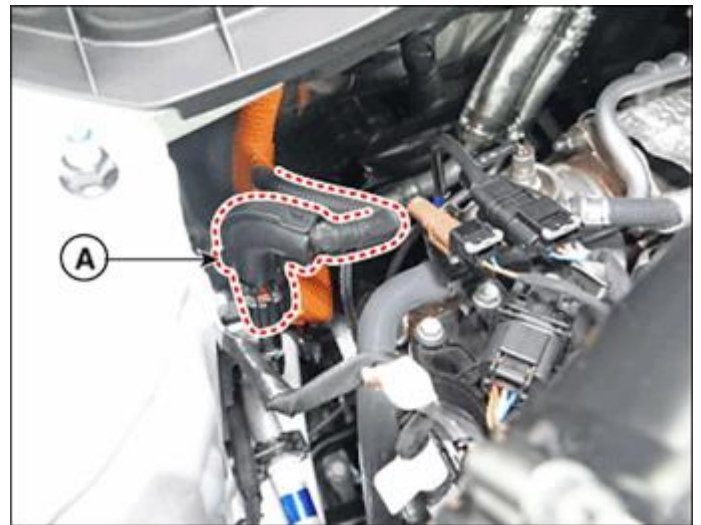

4. Use the following procedure to remove the service interlock connector and disable the high voltage battery:

a) Remove the service interlock connector (A) located at the engine room left side.



a) If the Service Interlock connector cannot be disconnected, cut the wire attached the yellow warning label.

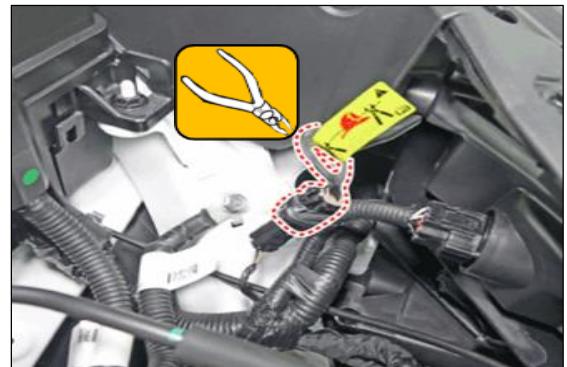

WARNING

Wait for more than 3 minutes so that the capacitor in the high voltage system can be fully discharged.

II . Disabling the system – IG Relay Removal (Alternate Method)

1. Open the bonnet.
2. Remove the engine bay fuse & relay box cover.

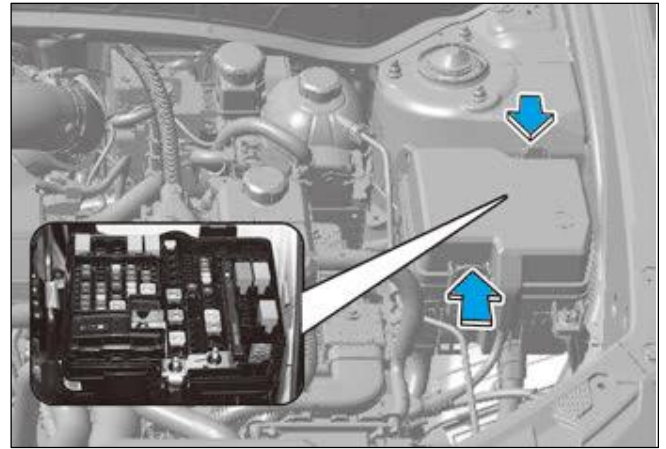

3. In the event the vehicle cannot be disabled using the “Power” START/STOP Button, pull the IG1, IG2 fuses or relays from the – engine bay fuse box. If the IG fuses cannot be located, pull out all the fuses and relays in the fuse box.

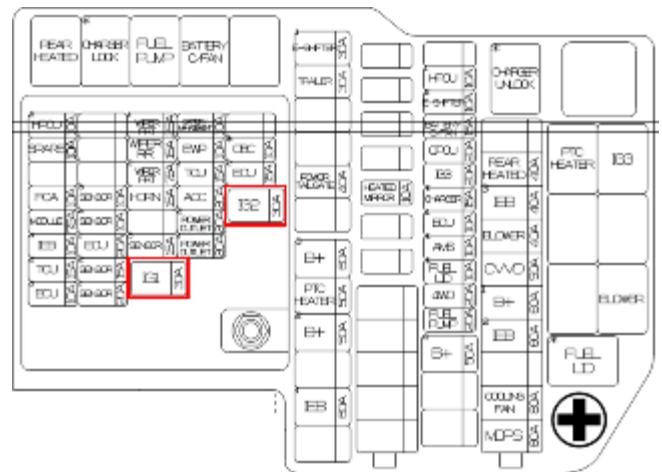

4. Separate the positive (+) 12V battery cable (A), located at the engine room to further prevent the risk of accidental restart.



NOTICE

If necessary, lower the windows, unlock the doors and open the boot as required, before disconnecting the 12V battery. Once the 12V battery is disconnected, power controls will not operate.

5. Use the following procedure to remove the service interlock connector and disable the high voltage battery:

- a) Remove the service interlock connector (A) located at the engine room left side.



- a) If the Service Interlock connector cannot be disconnected, cut the wire attached the yellow warning label.



WARNING

Wait for more than 3 minutes so that the capacitor in the high voltage system can be fully discharged.

If both methods of disabling system are unsuccessful, the vehicle is not secured from accidental deployment of airbags and electric shock from high-voltage components.

WARNING **Electrocution Risk!**

- Before engaging in emergency response procedures, ensure the vehicle is disabled and wait for more than 3 minutes to allow the capacitor in the high voltage system to discharge to avoid electrocution.
- Exposed cables or wires may be visible inside or outside the vehicle. To prevent injury or death due to electrical shock, never touch the wires or cables before disabling the system, to prevent injury or death due to electrical shock.

Failure to follow any of these instructions may result in serious injury or death by electrocution.

WARNING **Explosive Risk!**

- Do not cut through any component.
- SRS components may remain powered and active for up to 3 minutes after the 12V electrical system is shut off or disabled. Disconnect the battery negative cable and wait for at least 3 minutes before beginning work.

Failure to follow any of these instructions may result in serious injury or death from accidental deployment of the airbag system.

Lifting / Jacking Operations

The TUCSON Hybrid model, because of the high voltage components contained therein, first responders should exercise extreme caution when they extract occupants in the car. Before performing any extraction operations, the first responders should "Identify, Immobilise and Disable" the vehicle as discussed in sections on emergency procedures.

Vehicle Stabilisation

Use standard stabilisation (cribbing) points, as shown. Always be sure to connect to a structural member of the vehicle and avoid placing cribbing under high voltage cables, fuel lines and other areas not normally considered acceptable.

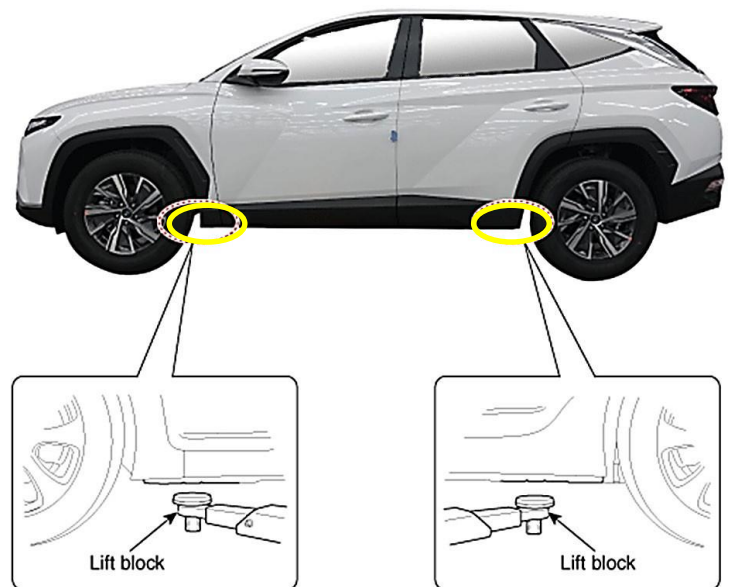





Extraction Tools & Procedure

When responding to an incident involving a Tucson Hybrid, we recommend that the first responders follow their organization's standard operating procedures for dealing with vehicle emergencies. When the first responders cut the vehicle, they should always pay special attention to the airbag system, orange colored high voltage cables and other high voltage components so that the parts are not damaged and to prevent a risk of electric shock or explosion.

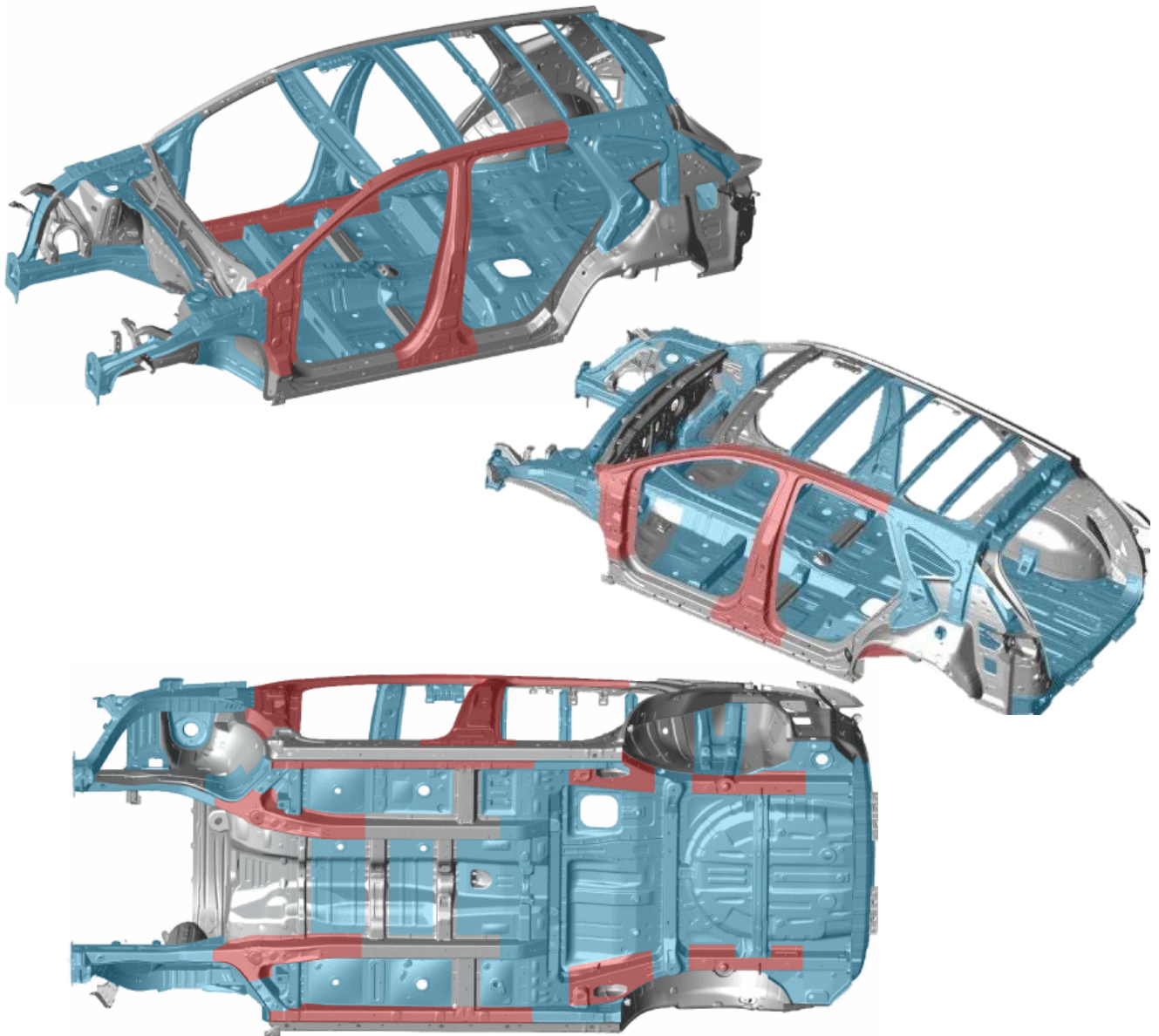
Location of ultra-high strength steel

In these images, high strength steel is used in the areas colored in blue and ultra-high strength steel is used in the red colored areas. Depending on the tools used, ultra high strength steel can be challenging or extremely difficult to cut. If necessary, use a workaround technique.









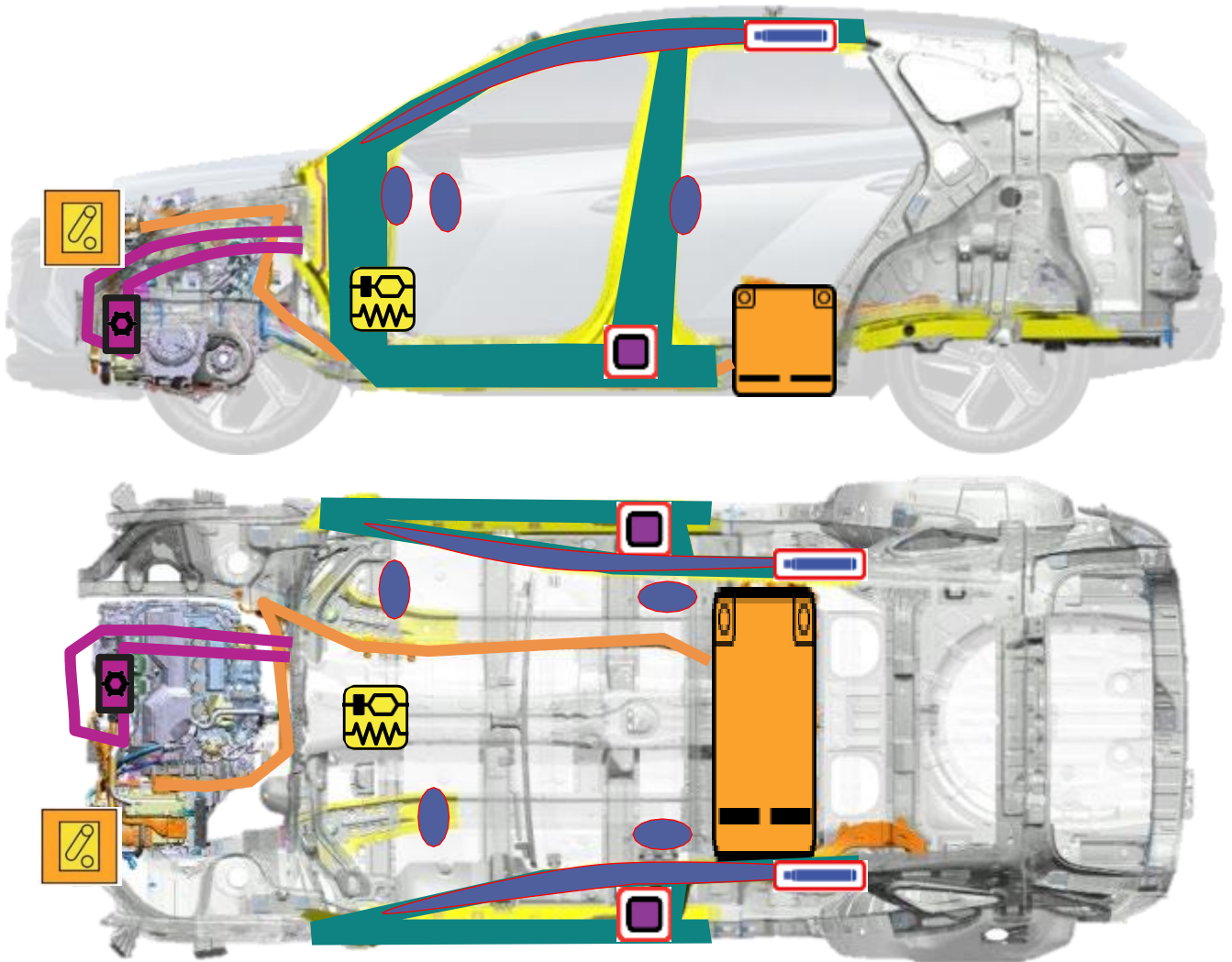





-  Mild steel
-  High strength steel
-  Ultra-high strength steel

Extrication Tools & Procedure

When responding to an incident involving an TUCSON Hybrid, we recommend that the first responders follow their organization's standard operating procedures for assessing and dealing with vehicle emergencies. When the first responders cut the vehicle, they should always pay special attention to airbag system, orange coloured high voltage cables and other high voltage components to avoid damage to parts which may increase the risks of explosion.



 Supplemental Restraint System Control Module (SRSCM)	 Airbag	 Airbag Gas Inflators
 High voltage cable	 12 Volt Battery	 Air-conditioning line
 Low Voltage Disconnect for High Voltage	 OBC (On – Board Charger)	 Ultra-High Strength Steel
 High Voltage Battery	 Air-conditioning component	 Seat belt pretensioner

Airbag System Components

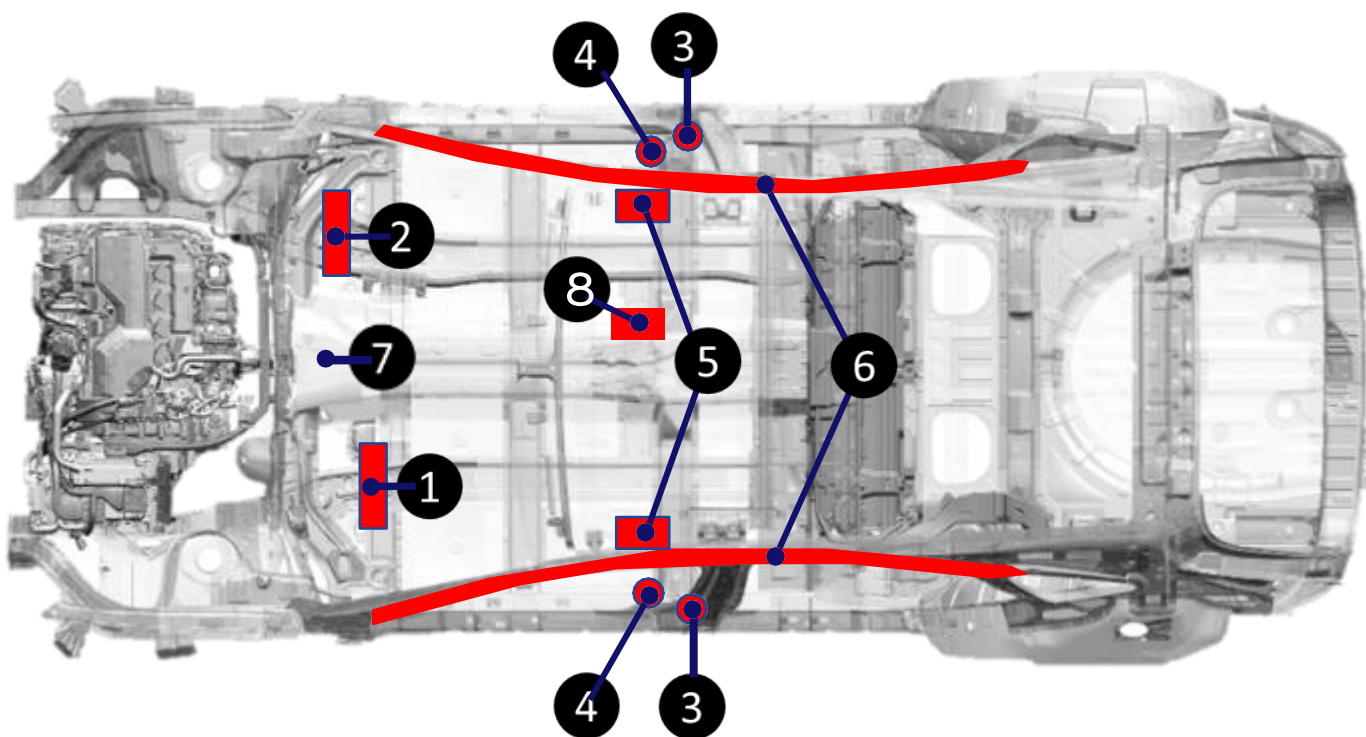

- 1. Passenger's front airbag
- 2. Driver's front airbag
- 3. Seat Belt Pretensioner (FBPT)
- 4. Emergency Fastening Device (EFD)
- 5. Side Airbag (Driver, Passenger side)
- 6. Curtain Airbag (Driver, Passenger side)
- 7. Supplemental Restraint System Control Module (SRSCM)
- 8. Driver's Centre Airbag

Seat Belt Systems

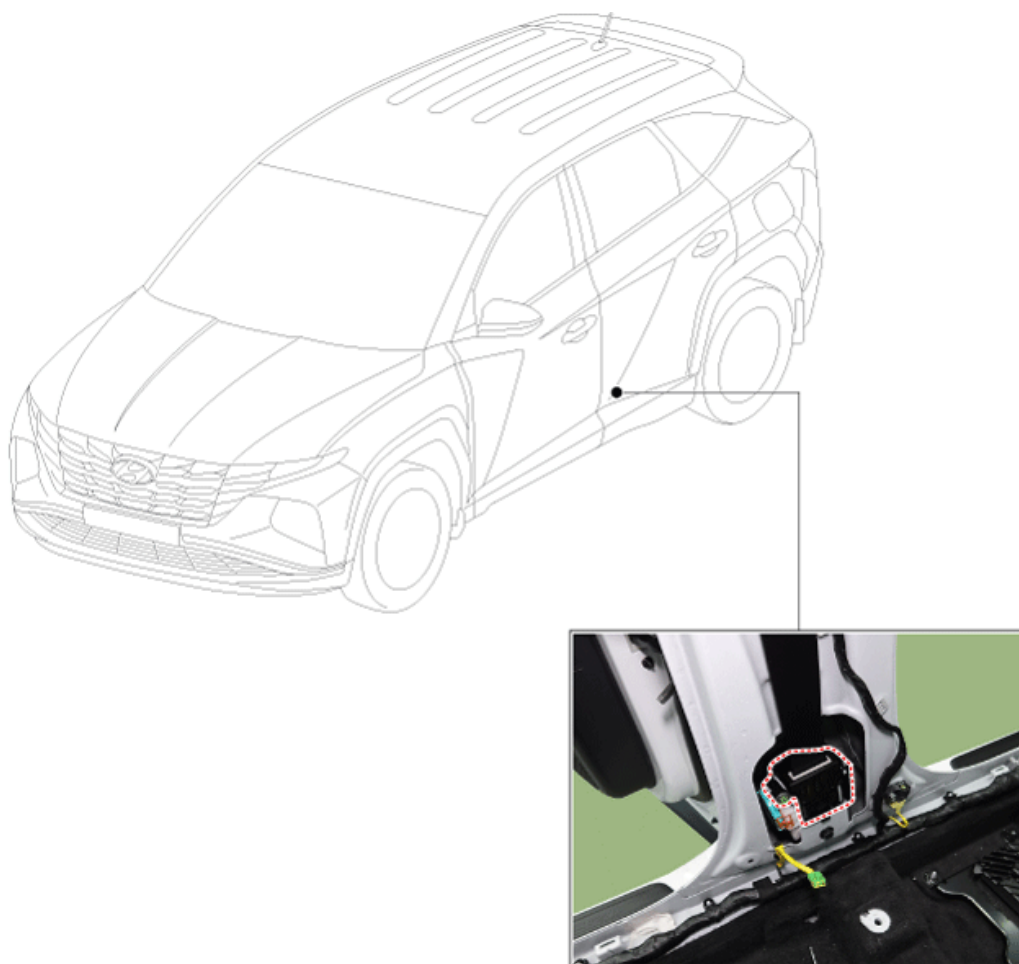

CAUTION

Undeployed Airbags

To avoid injuries caused by accidental deployment of undeployed airbags

- Do not cut the red colored part shown in the image above.
- Make sure the vehicle ignition switch is turned off, disconnect the 12 Volt auxiliary battery (located in the left side of engine room) and wait 3 minutes or longer to allow the system to deactivate.

Failure to follow any of these instructions may result in serious injury or death from accidental deployment of the airbag system.

Submersion

Some emergency responses can involve a submerged vehicle. A Tucson Hybrid that is submerged does not have high-voltage component on the vehicle's body or framework. It is safe to touch the vehicle's body or framework if there is no severe damage to the vehicle, whether it is in water or on land.

In the event the vehicle is submerged or partially submerged, remove the vehicle from the water before attempting to disable the vehicle. Drain the water from the vehicle. Use one of the methods described in sections of page 22 - 26 to disable the vehicle.

WARNING

- If severe damage causes high-voltage components to become exposed, responders should take appropriate precautions and wear appropriate insulated personal protective equipment.
- Do not attempt to remove a Service Disconnect Plug while in the water

Failure to follow any of these instructions may result in serious injury or death by electrocution.

Vehicle Fire

After Initial Emergency Response Procedures have been applied, Firefighting Procedures may begin. Hyundai recommends that each response team follow their own department's standard operating procedures for fighting vehicle fires in combination with the Tucson Hybrid specific details that are covered in this section.

Firefighting Operations

If the high-voltage battery pack is either involved in or at risk of being involved in a fire in a Tucson Hybrid, strict cautions must be taken while conducting firefighting operations due to following reasons:

Lithium-ion Polymer batteries contain gel electrolyte that can vent, ignite, and produce sparks when subjected to temperatures above 150°C

May burn rapidly with a flare-burning effect.

Even after the high-voltage battery fire appears to have been extinguished, renewed or delayed fire can occur.

- Use a thermal imaging camera to ensure the high voltage battery is completely cooled before leaving the incident.
- Always advise second responders that there is a risk of the battery re-igniting.
- Fire, submersion or a collision that has compromised the high voltage battery, always store it in an open area with no exposures within 50 feet / 15 meters.

A burning battery could release hydrogen fluoride, carbon monoxide, and carbon dioxide gasses. Use NIOSH/MSHA approved full-face self-contained breathing apparatus (SCBA) with full protective gear. Even if the high-voltage battery pack is not directly involved in a vehicle fire, approach the vehicle very carefully.

Extinguishers

Small fires that high voltage battery is not involved : Extinguish fires using a ABC extinguisher for an electric fire.

Fires that the high voltage battery is involved, or the high voltage battery is heating : Extinguish fires using large and sustained amount of water to cool the high voltage battery. Do not extinguish fire with a small amount of water. Firefighters should not hesitate to pour large amounts of water on the vehicle.

High-Voltage Battery Damage and Fluid Leaks

The High-voltage Battery assembly is enclosed in a sturdy metal case that is rigidly mounted to structural components of the vehicle. This construction helps prevent damage to the High Voltage Battery assembly even in severe crashes. This section provides emergency responders with information regarding how to mitigate the severity of a damaged High Voltage Battery assembly or gel electrolyte spill, however unlikely that might be.

- Cease all smoke, spark, flame activity around the vehicle.
- Electrolyte solution is a skin irritant.
- Do not touch or step on the spilled electrolyte.
- If electrolyte leak occurs, wear appropriate solvent resistant PPE and use oil, sand, or a dry cloth to clean up the spilled electrolyte. Be sure to adequately ventilate the area.

⚠ WARNING Irritant Substance Risk!

- Internal components of the High Voltage Battery are irritants and sensitizers.
- To avoid contact with these irritants and sensitizers wear positive pressure self-contained breathing apparatus (SCBA) and other personal protective equipment (PPE) designed for use with these types of hazards.

Failure to wear proper SCBA and PPE can result in serious injury or death

- Electrolyte solution is an eye irritant – If contact with eyes, rinse with plenty of water for 15 minutes.
- Electrolyte solution is a skin irritant. Therefore, if there is contact with skin, wash off with soap.
- Electrolyte liquid or fumes that have come into contact with water vapors in the air will create an oxidized substance. This substance may irritate skin and eyes. In these cases, rinse with plenty of water and see a doctor immediately.
- Electrolyte fumes (when inhaled) can cause respiratory irritation and acute intoxication

Move to a well ventilated location for fresh air and wash mouth with water. See a doctor immediately.

Towing

When towing TUCSON Hybrid vehicle, all wheels should be off the ground and not in contact with the road. If emergency towing is necessary, we recommend having it done by an authorised Hyundai dealer or a commercial tow-truck service. The use of wheel dollies or flatbed is recommended.

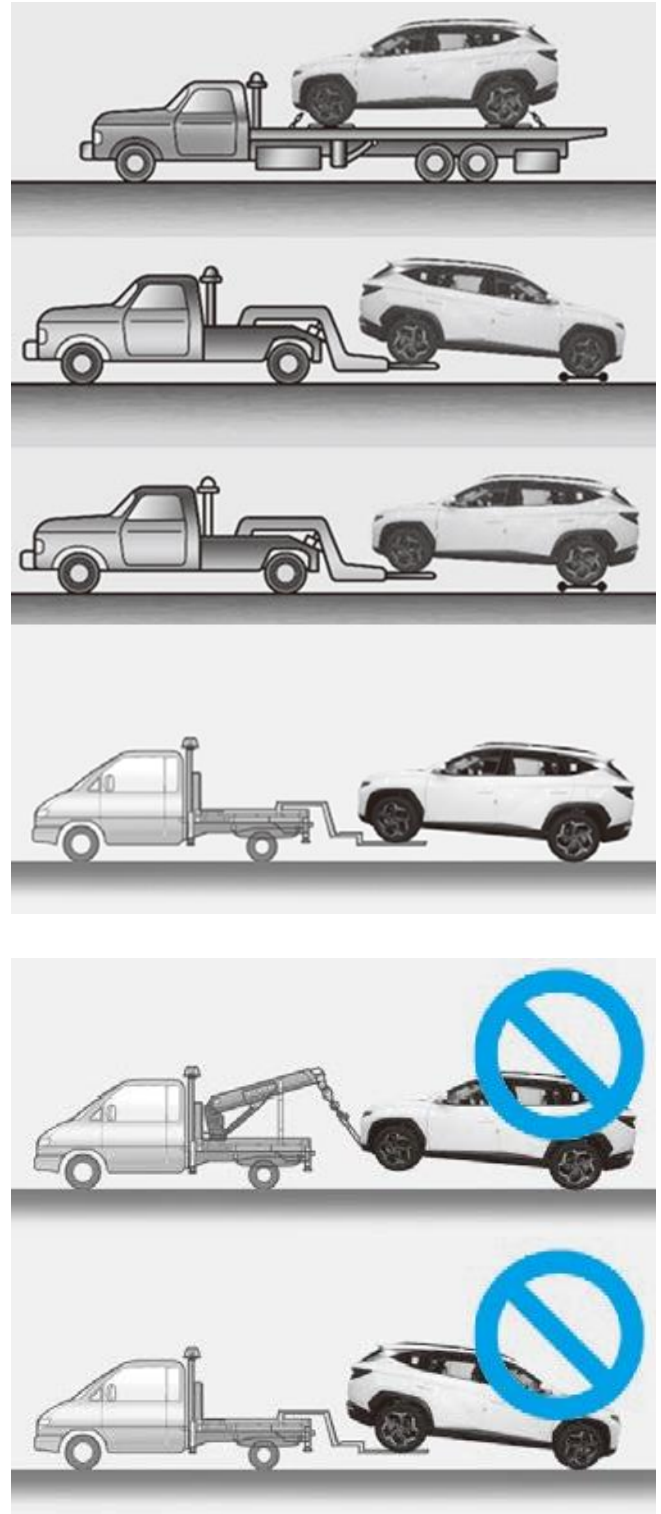

CAUTION

- Do not tow the vehicle backwards with the front wheels on the ground as this may cause damage to the vehicle.
- Do not tow with sling-type equipment. Use wheel lift or flatbed equipment.
- Never tow the vehicle with the front wheels on the ground (forward or backward), as this may cause damage to the vehicle.

To Jump Start the Car

Before Jump Starting

Press the 12 Volt Battery Reset switch to reconnect the 12 Volt battery.

Start the vehicle within 15 seconds of pressing the 12 Volt Battery Reset switch.

After starting vehicle (READY indicator on), operate the vehicle safely outdoors in ready mode stopped and/or drive it for 30 minutes total to charge the 12 Volt battery fully.



CAUTION

- Do not connect the cables to or near any part that moves when the vehicle is started.
- Do not allow the jumper cables to contact anything except the correct battery terminals or the correct ground.
- Do not lean over the battery when making connections.
- **Do not jump start another vehicle with hybrid vehicle. Jump starting another vehicle will damage the hybrid vehicle's 12 Volt battery (Lithium Polymer type).**

Jump Starting

If the 12V battery is over discharged to a point that the reset does not work, try to jump-start the vehicle.

1. Position the vehicles close enough that the jumper cables will reach, but do not allow the vehicles to touch.
2. Avoid fans or any moving parts in the engine compartment at all times, even when the vehicles are turned off.
3. Turn off all electrical devices such as radios, lights, air conditioning, etc. Put the vehicles in P (Park) and set the parking brakes. Turn both vehicles OFF.

4. Connect the jumper cables in the exact sequence shown in the illustration. First connect one jumper cable to the red, positive (+) jumper terminal of your vehicle (1).
5. Connect the other end of the jumper cable to the red, positive (+) battery/jumper terminal of the assisting vehicle (2).
6. Connect the second jumper cable to the black, negative (-) battery/chassis ground of the assisting vehicle (3).
7. Connect the other end of the second jumper cable to the black, negative (-) chassis ground of your vehicle (4). Do not allow the jumper cables to contact anything except the correct battery or jumper terminals or the correct ground.
8. Start the engine of the assisting vehicle and let it run for a few minutes.
9. Press the 12 Volt Battery Reset switch.
10. Start your vehicle as soon as possible. After starting vehicle (READY indicator on), operate the vehicle safely outdoors in ready mode stopped and/or drive it for 30 minutes total to charge the 12 Volt battery fully.

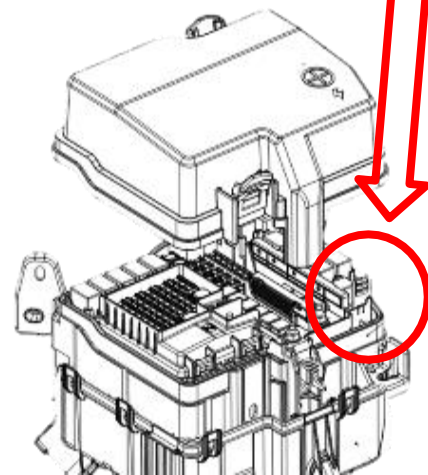
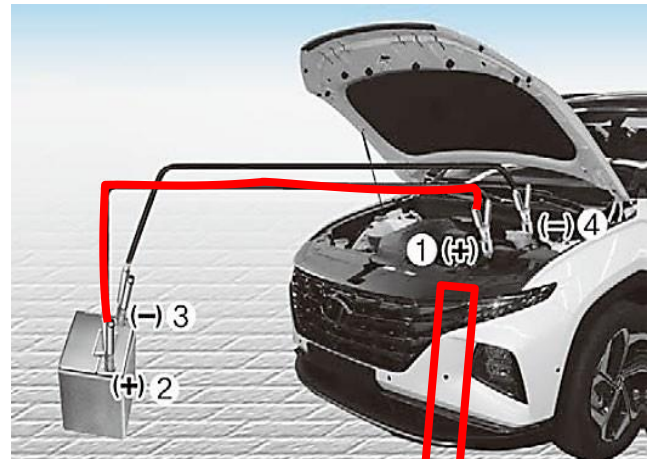

11. If the cause of your battery discharging is not apparent, we recommend that the system be checked.

CAUTION

- Do not attempt to jump start the high voltage battery.
- Failure to follow these instructions will lead to serious bodily injury or death by electrical shock

HYUNDAI HELP LINE
0800 HYUNDAI (498 632)